

Installation Instructions

Congratulations! You are about to make your plain mirror a beautiful, decorative accent. We want you to be delighted with the outcome, so follow these instructions carefully and please call our customer service line (866) 304-6283 if you have any questions or problems. Hours: Monday through Saturday 9:00 - 5:00 EST.

What's included with your order:

If anything is missing, please call us at (866) 304-6283

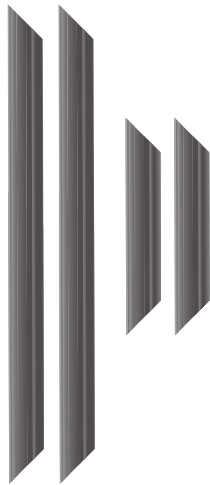

4 Frame Sections

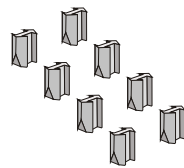

8 Frame connectors

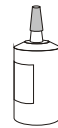

1 Bottle wood glue

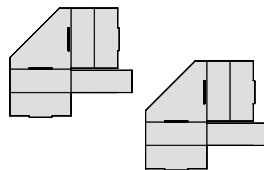

2 Placement corners



4 Adhesive strips

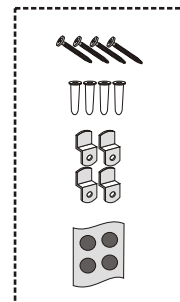

Replacement
Clip Pack
(if your mirror is
hung with clips)

What you'll need:

- damp rag
- small hammer or rubber mallet
- level -- optional, but recommended
- a buddy
- blow dryer

Assembling the Frame

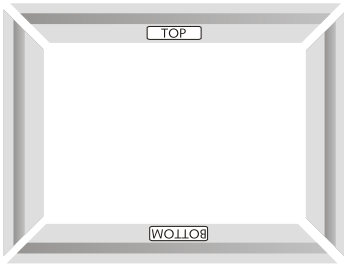

- 1** Lay out the four frame sections *FACE DOWN* on a flat surface and position the pieces as shown.

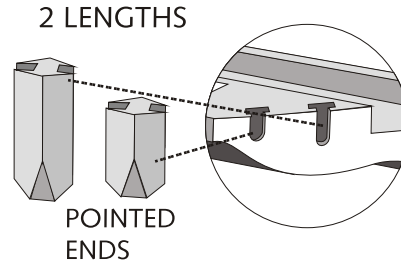

- 2** Take out the plastic corner connectors, and note whether there are two different lengths. Find the corresponding slots on the frame pieces. Note: Some frames use equal length connectors.

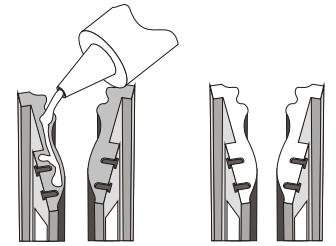

- 3** Apply glue to two adjoining ends. Spread out evenly so that the entire end of each piece is coated.

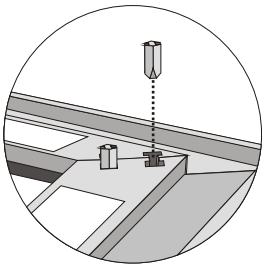

- 4** Align the glued ends and insert the **PROPER LENGTH CONNECTOR** into the slot, pointed end first. Insert the other connector. Press in both connectors with your thumb.

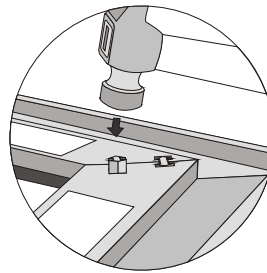

- 5** If you need, lightly tap in connectors with hammer or mallet until they are flush with the frame back.

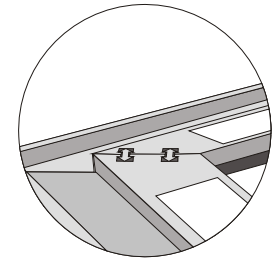

- 6** Repeat this process for the remaining sides of the frame.



- 7** Turn the frame over and look to see if the pieces on each corner are properly aligned with each other height-wise. Adjust as needed before glue dries.

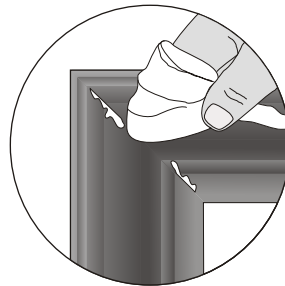

- 8** Finish by wiping off any excess glue with a damp cloth.

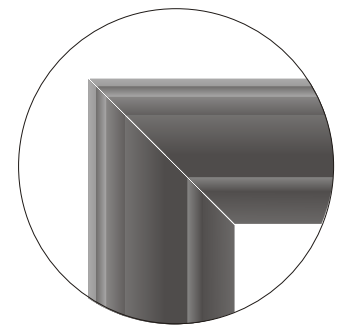

- 9** If you see a "white line," try to press one side so it better matches up with the other. Again, check for any glue and immediately wipe off with damp rag.

10 Let frame dry one hour. While your frame dries, clean your mirror with a mix of 50% water/50% isopropyl alcohol. Do not use glass cleaner, as it leaves a chemical residue. Be sure to get the entire perimeter good and clean so that the mounting tape will adhere properly. Wipe dry with a lint free cloth.

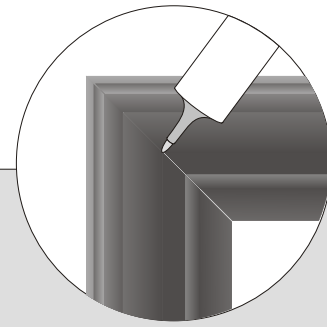

Framer's tip: Sometimes a frame corner will show a white line at the miter. This is not abnormal. Framers often use a water-based marker to stain the "line" the color of the frame. For a gold frame, use a beige marker; for a silver frame, try a grey one. For wood frames, just choose the closest color. Wipe any excess off with a damp rag.

Installing the Frame

DO NOT REMOVE ADHESIVE BACKING FROM THE BACK OF THE FRAME AT THIS TIME!

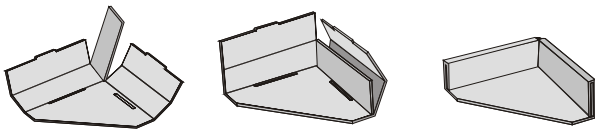

1 Fold the two cardboard placement corners into shape like this.

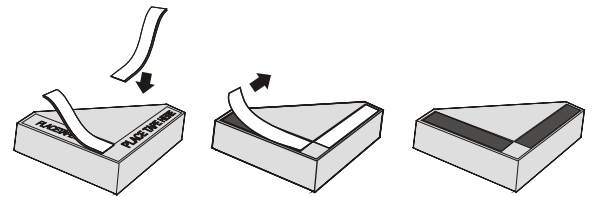

2 Flip over, and apply the 2-sided foam tape as shown. Press strips down firmly. Remove liner to expose adhesive.

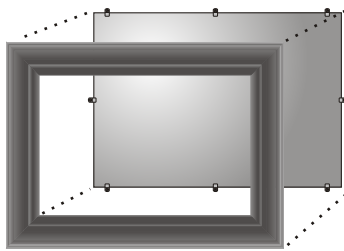

3 Carry the frame to the mirror. Test fit the frame, fitting it over clips if you have them. The back of the frame must contact the mirror surface evenly on all sides. If your clips do not fit into the channel in the back of the frame, go to step 4. If the frame contacts the mirror correctly, proceed to step 5. If your frame is slightly warped, it will be corrected when the frame is adhered to the mirror.

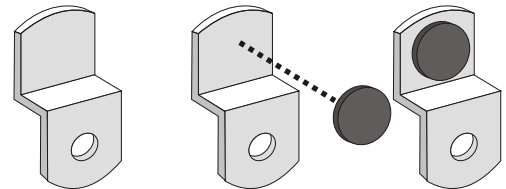

4 Certain large clips won't work properly with MirrorMate frames. We have supplied replacement clips to be used in place of your existing clips, should you have problems fitting your frame to the mirror. Replace the old clips one by one with the replacement clips. Make sure that these new clips are securely anchored to the wall, preferably into wall studs.

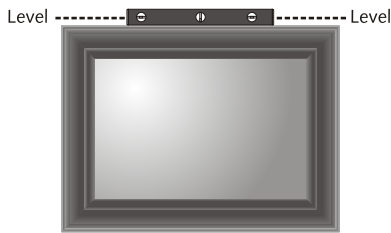

5 Position the frame against the mirror and make sure that each edge of the frame covers the mirror completely. Use a level if you have one to level the frame. When the frame is where you want it, have your buddy get the two Placement Corners.

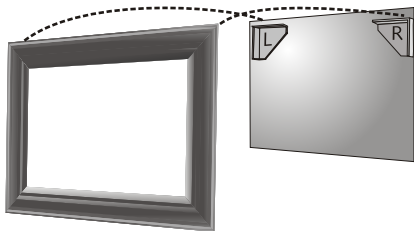

7 Take the frame down, making sure not to move the Placement Corners.

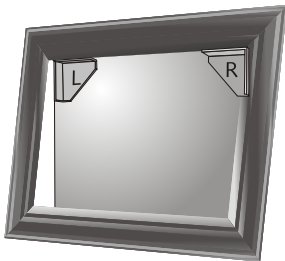

9 Carefully carry the frame back to the mirror and without touching the adhesive strips to the mirror, rest it on top of the Placement Corners.

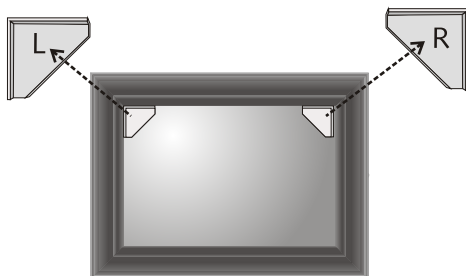

10 Remove Placement Corners. Remove remaining tape by heating with blow dryer for several seconds, and rolling off adhesive with finger. If it does not roll off easily, you can use a citrus-based or petroleum-based cleaner such as Goof Off .

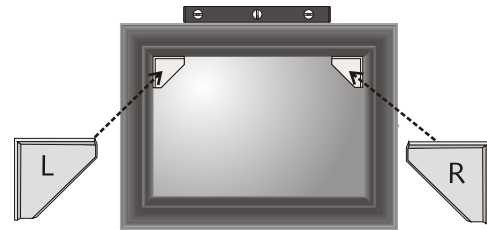

6 Press Placement Corners ("L" for left, "R" for right) into both upper inside corners, as shown. Make sure the corners are positioned tightly into the corners, then press firmly onto the mirror.

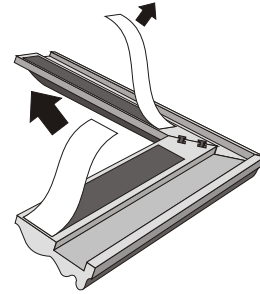

8 Now peel off the backing from the adhesive strips. Be careful not to touch anything with the adhesive strips; they are extremely sticky and permanent.

Check frame with level again. Push the frame towards the mirror starting with the top edge first. Push firmly with your hands along the entire surface of the frame, to affix it permanently.

IF YOU MAKE A MISTAKE, **IMMEDIATELY PULL THE FRAME AWAY** FROM THE MIRROR. IF ANY TAPE STRETCHES OUT, CUT IT AWAY FROM THE FRAME WITH A SCISSORS. DON'T WORRY! CALL US AT (866) 304-6283 FOR HELP.

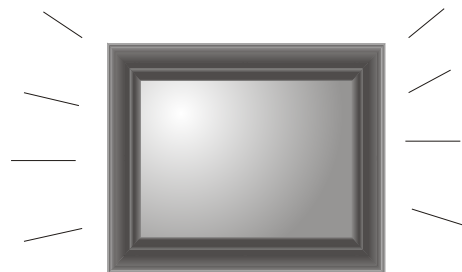

Stand back and look at your gorgeous, framed mirror!